













## Contents

1 Symbol Description .....	2
2 Safety Precautions .....	3
2.1 Before Connecting .....	3
2.2 In Using .....	4
3 Introduction .....	4
3.1 Features .....	5
3.2 Specification .....	6
3.3 Equipment interface instruction .....	7
4 Safe Handling of Lithium-iron Batteries Guide .....	14
4.1 Solution Diagram .....	14
4.2 Danger Label .....	14
4.3 Tool .....	15
4.4 Safety Gear .....	15
5 Installation and operation .....	15
5.1 Package items .....	15
5.2 Installation Location .....	16
5.3 Installation Direction .....	17
5.4 Installation Steps .....	18
5.5 System turns on .....	22
5.6 System turns off .....	22
6 Emergency Situations .....	23
6.1 Battery Leakage .....	23
6.2 On Fire .....	23
6.3 Wet Batteries .....	23
6.4 Damaged Batteries .....	23
7 Remarks .....	24
7.1 Recycle and Disposal .....	24
7.2 Maintenance .....	24
7.3 Declaration of conformity .....	24
8 Fault checklist .....	24

Please read this manual before you install the battery and follow the instruction carefully during installation process. Electrical installation, maintenance must be performed by professional/qualified personnel. Please contact us immediately for advice and clarification if you have any question.

## 1 Symbol Description

	Do not place near open fire or flammable materials.
	A potential hazard exists when the equipment is working. Wear personal protective equipment during operation.
	Warning electric shock. Power off the equipment before any operation.
	Grounding: indicate PE cable connection position.
	Do not place in areas accessible to children.
	Keep the battery away from open fire or ignition sources.
	Please use the equipment reasonably. In extreme cases, the equipment may cause explosion risk.
	The equipment contains corrosive electrolyte. Please avoid contact with leaked electrolyte or volatile gas.
	Read the product and operation manual before operating the battery system.
	Label for Waste Electrical and Electronic Equipment (WEEE) Directive (2012/19/EU)
	The certificate label for CE.
	Recycle label.

## 2 Safety Precautions



Alert

- (1) It is important and necessary to read the user manual carefully (and attachment) before installing or using battery. Failure to do so or to follow any instruction or warning in this document can result in electrical shock, serious injury, and death, or damage battery, potentially rendering it unusable.
- (2) When battery is stored for a long time, it is required to charge once every 6 months, and the SOC should be no less than 85%.
- (3) After battery module lack of electricity, it needs to be recharged within 12h.
- (4) Do not connect power terminal reversely.
- (5) All power supplies must be disconnected during maintenance.
- (6) Please contact the supplier within 24 hours if there is something abnormal.
- (7) Do not use any liquid to clean the battery.
- (8) Do not expose battery to flammable or irritating chemicals or vapor.
- (9) Do not paint any part of battery, including any internal or external components.
- (10) Do not connect battery with PV solar wiring directly.
- (11) Do not install or use this product beyond provisions of the manual.
- (12) Direct or indirect damages caused by the above reasons are not covered by warranty claim.



Warning

### 2.1 Before Connecting

- (1) Please check the external packaging condition before unpacking. If it is damaged, contact corresponding local retailer.
- (2) After unpacking, please check the products and spare parts according to spare parts list. If the product is damaged or missing, please contact your local retailer.
- (3) Connect to specified matching inverter.
- (4) Before installation, be sure to cut off the grid power and make sure battery is in turned-off mode.

- (5) It is prohibited to connect the battery and AC power directly.
- (6) All electrical wiring must be connected in accordance with local regulations.
- (7) Please ensure that electrical performance of battery system is compatible with the equipment.
- (8) The installation onsite shall be equipped with fire-fighting facilities that meet relevant requirements, such as fire sand, dry powder fire extinguisher, etc.

### 2.2 In Using

- (1) If battery system needs to be moved or repaired, power must be cut off and battery is completely shut down.
- (2) Do not connect battery to faulty inverter.
- (3) In case of fire, only dry powder fire extinguisher can be used, liquid fire extinguishers are prohibited.
- (4) Do not open, repair or disassemble the battery except NAHUI personnel or other authorized personnel. The company shall not bear any liability or responsibility caused by violation of any safety operation or design standard, production standard, equipment safety standards or any other standards or requirements.

## 3 Introduction

NHS-1Y ( 10/15/20/25/30/35/40)K is a plug-in energy storage system consisting of battery module HV5120-S1-N and control box SHB1000PRO-N, which can provide reliable power supply for all kinds of equipment or systems. NHS-1Y ( 10/15/20/25/30/35/40)K has built-in BMS battery management system, which can manage and monitor cells information including voltage, current and temperature.



Figure 3-1

### 3.1 Features

- (1) Built-in soft-start function to reduce current impact.
- (2) When multiple modules are series connected, module addresses are set automatically.
- (3) Support for upgrading the battery module from the upper controller through CAN communication.
- (4) The module is non-toxic, non-polluting and environmentally friendly.
- (5) Cathode material is made from  $\text{LiFePO}_4$  with safety performance and long cycle life.
- (6) Battery management system (BMS) has protection functions including over-discharge, over-charge, over-current and high/low temperature.
- (7) The system can automatically manage charge and discharge state and balance voltage of each cell.
- (8) Flexible configuration, multiple battery modules can be connected to expand capacity and power. Expandable to 10-40kwh (2-8 batteries connected in series).
- (9) Adopted self-cooling mode rapidly reduced system entire noise
- (10) The module has less self-discharge, up to 6 months without charging it on shelf, excellent performance of shallow charge and discharge.

### 3.2 Specification

#### Parameters

No.	Items	Specification
1	Module Model	HV-5120-S1-N
2	Battery Type	LFP 1P32S
3	Total Capacity*1	5.12kWh
4	Rated Capacity*2	4.86kWh ( 95% DOD )
5	Nominal Voltage	102.4V
6	Working Voltage	91.2~115.2V
7	Charging Voltage	112V
8	Max. Charge Current*3	25A
9	Max. Discharge Current*4	40A
10	Communication	RS485 ,CAN,WiFi
11	Storage Temperature	0 ~ 45°C ( Recommended )
12	Storage Humidity	≤85%( RH )
13	Working Temperature	Charging: -10°C ~ 50°C、 Discharging: -20°C ~ 50°C
14	Working Humidity	≤95%( RH ) No Condensation
15	Working Altitude	≤2000m
16	Ingress Protection	IP65
17	Protective Class	I
18	Weight	~45kg
19	Dimension(W*D*H)	636mm*330mm*188mm
20	Design Life	15 Years ( 25°C )
21	Cycle Life	> 6000 ( 25°C , 0.5C/1C, 95%DOD )
22	Scalability	Module: 2-8S, Up to 8 cabinets in parallel
23	Certification	IEC62619, IEC63056, CE EMC, UN38.3
24	Warranty	10 years

\*1 Test conditions: cell voltage 2.0~3.65V, 25 ± 2 °C , 0.5C charge and 1C discharge.

\*2 Test conditions: 95% depth of cell discharge , 25 ± 2 °C , 0.5C charge and 1C discharge.

\*3、\*4 Depend on the temperature and SOC of battery.

\*5 Trickle charging at -10°C-0°C, it is recommended to use at 0°C-50°C

## Dimensions

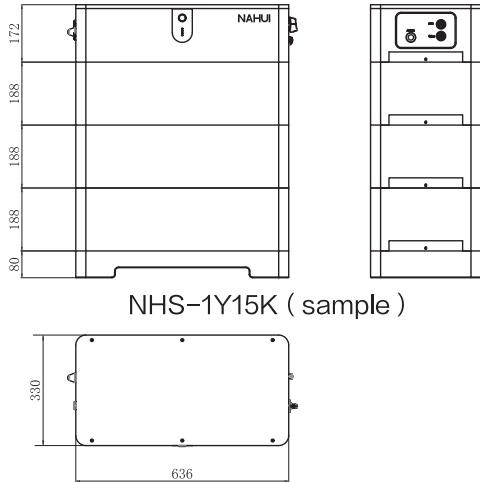

NHS-1Y15K ( sample )

Figure 3-2

## 3.3 Equipment interface instruction

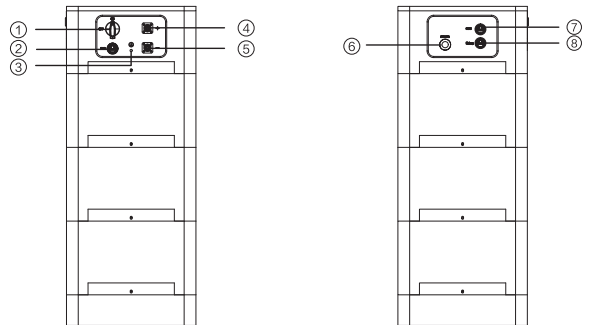

Figure 3-3

- ① Isolating Switch
- ② To PCS communication
- ③ Ground
- ④ Positive Power Terminal
- ⑤ Negative Power terminal
- ⑥ Antenna
- ⑦ COM(Parallel communication)
- ⑧ Debug

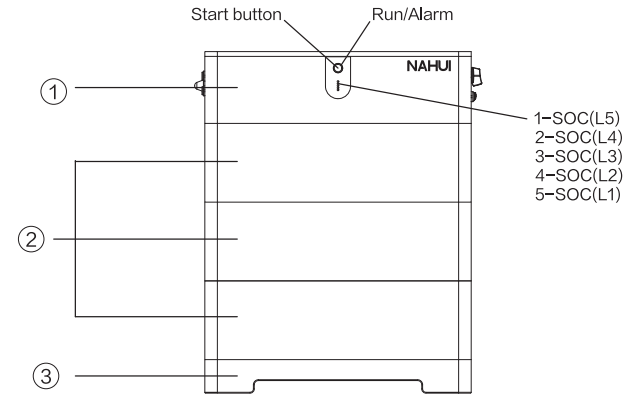

Figure 3-4

- ① Control module
- ② Battery module
- ③ Mounting the base

### Start

Turn on: When battery is dormant, press the START button to start the battery module.

Black start: When the PV and Grid are out of power, press the START button for more than 10 seconds to start the battery to power the inverter, and the inverter adjusts the battery to power the load.





### Run/Alarm

Blue LED lighting to show the battery system is running or having alarm.

Status	Mode	Run/Alarm	Remark
Power off	Power off		Light is off
Run	Standby/Charge/Discharge		Light is on
Alarm	Level I Alarm		System can run, but there will be alarm tips
	Level II Alarm		System will stop, and check the problem































## Note

### Description of indicator light



-  The indicator light is off.
-  The indicator light is on
-  The indicator light is flashing. Duration of indicator on is 0.25s, Duration of indicator off is 3.75s.
-  The indicator light is flashing. Duration of indicator on is 0.5s, Duration of indicator off is 1.5s.

## SOC

Green LEDs are used to show the battery's remaining capacity.

State		Charge/Discharge				
Capacity Indicator LED		L5	L4	L3	L2	L1
SOC	0 ~ 20%					
	20 ~ 40%					
	40 ~ 60%					
	60 ~ 80%					
	80 ~ 95%					
	95 ~ 100%					

## Note

-  The SOC indicator light is off.
-  The SOC indicator light is on.
-  The SOC indicator light is flashing, Duration of indicator on is 0.5s, Duration of indicator off is 0.5s.

## Isolating Switch

When you rotate the Isolating Switch to ON position, Positive Power Terminal will connect with the HV+ battery contactor and Negative Power Terminal will connect with the battery HV-, on the other hand, when Isolating Switch is at OFF position both connection will off.

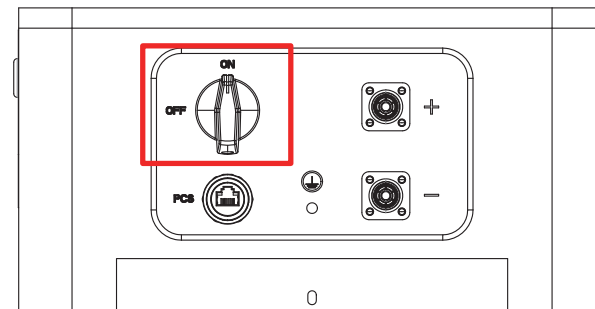

Figure 3-5

## Power Terminal

Power cable terminals: There are two pairs of terminals with the same function, which are respectively connected to the inverter and battery module. For power cables uses water-proofed connectors. Must keep pressing this Lock Button while pulling out the power plug.



Figure 3-6

## To PCS

Be used to communicate with inverter or upper battery.

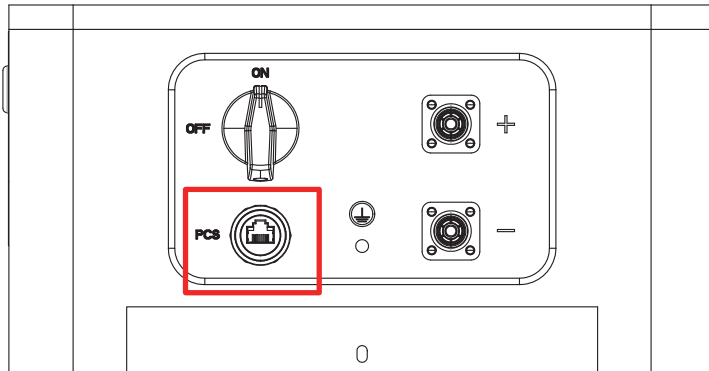

Figure 3-7

## COM

CAN communication port with upper computer.

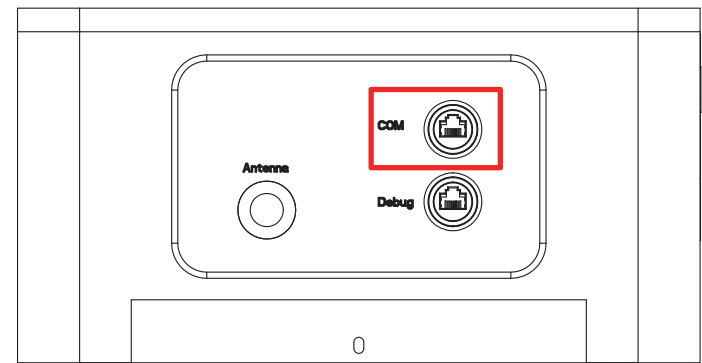
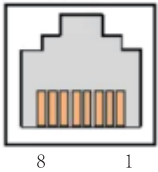

Figure 3-8

## RJ45 Socket



Pin	Definition
1	RS485-1A
2	RS485-1B
3	Undefined
4	CAN3-H
5	CAN3-L
6	Undefined
7	CAN1-H
8	CAN1-L

RS485-1: Communication with PCS by RS485. (RS485-1A RS485-1B).

CAN3: Communication with PCS by CAN. (CAN3-H CAH3-L).

CAN1: Master/slave communication channel. (CAN1-H CAH1-L).

## RJ45 Socket

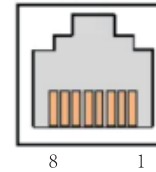

Pin	Definition
1	Undefined
2	Undefined
3	Undefined
4	Undefined
5	Undefined
6	Undefined
7	CAN2H
8	CAN2L

CAN communication: CAN bus for each rack and upper computer. (CAN2H CAH2L).

## Debug

For battery debug usage.

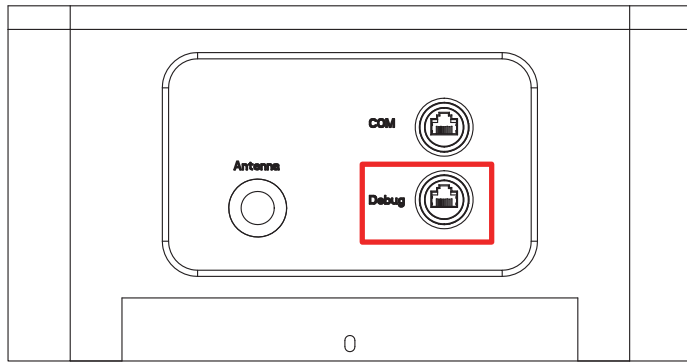
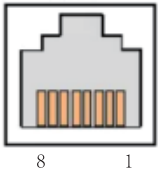

Figure 3-9

## RJ45 Socket



Pin	Definition
1	24V-
2	Undefined
3	Undefined
4	RS485-2B
5	RS485-2A
6	Undefined
7	24V-
8	24V+

24VDC: DC Input (Pin8 connect with 24V+, Pin1&pin7 connect with 24V-).

RS485-2: RS485 for upper computer or display monitor (RS485-2A RS485-2B).

## 4 Safe Handling of Lithium-iron Batteries Guide

### 4.1 Solution Diagram

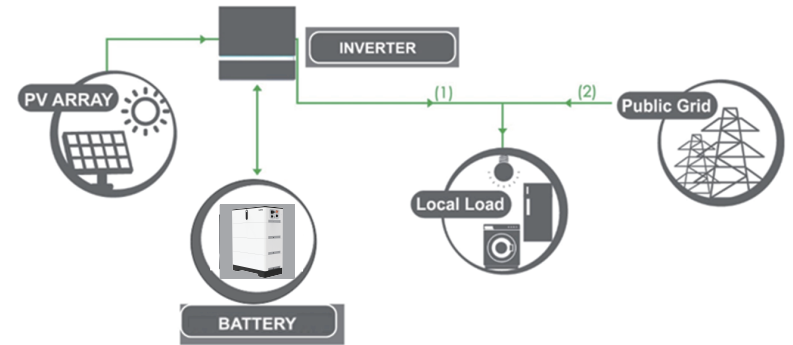

Figure 4-1

### 4.2 Danger Label

**WARNING**  
**DANGER LOW DC VOLTAGE INSIDE**  
**DANGER ARC FLASH & SHOCK HAZARD**

- \* Do not disconnect or disassemble by non-professional personnel.
- \* Do not drop, deform, impact, cut or spear with sharp objects.
- \* Do not place near open flame or flammable materials.
- \* Do not cover or wrap the product case.
- \* Do not come into contact with liquids.
- \* Be aware of high temperature.
- \* Avoid direct sunlight.
- \* Follow the product manual for wire connection.
- \* If any leakage, fire, wet or damage occur, switch off the breaker on DC side and stay away from the battery.
- \* Contact the supplier within 24 hours if failure occurs.

Figure 4-2

### 4.3 Tool

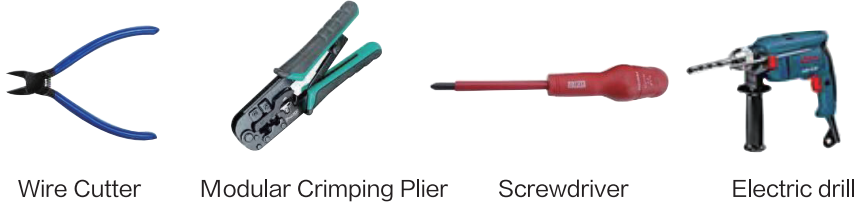

### Note

Properly use insulated tools to prevent accidental electric shock or short circuits. If insulated tools are not available, cover the entire exposed metal surfaces of the available tools, except their tips, with electrical tape.

### 4.4 Safety Gear

It is recommended to wear the following safety gear when dealing with battery pack.



## 5 Installation and operation

### 5.1 Package items

Unpacking and check the Package items

(1)For battery module package:

- Battery Module

(2)For packing box of high voltage box

NOTE: Power and communication cables connect to inverter belongs to the packing box of high voltage box.

- 2 \* 3000mm 8AWG power cables
- 1 \* 3000mm RJ45 communication cable
- 1 \* 3000mm 10AWG grounding cable



Figure 5-1

### 5.2 Installation Location

Make sure that installation location should meet the following condition:

- (1)The area should be completely water-proof.
- (2)The floor should be flat and level.
- (3)No flammable or explosive materials.
- (4)The ambient temperature is within the range from 0°C to 45°C.
- (5)The temperature and humidity are maintained at a constant level.
- (6)There is just a little dust and dirt in the area.
- (7)The distance from heat source should be more than 2 meters.
- (8)The distance from air outlet of inverter is more than 0.5 meters.
- (9)Installation areas should avoid direct sunlight.
- (10)No forced ventilation requirement for battery module, but please avoid installing in a closed area. Ventilation shall avoid high salinity  $\leq 30\%$ , humidity  $\leq 85\%$  and ambient temperature of 0 ~ 45 °C.



### 5.3 Installation Direction



Warning

Upside down	Sidelong	Sidelong
NOT allowed	NOT allowed	NOT allowed

Figure 5-2

### 5.4 Installation Steps



Warning

- (1) Follow local electric safety and installation policy, a suitable breaker between battery system and inverter is required.
- (2) All installation and operation must follow local electric standard and requirements.
- (3) When battery modules are paralleled, the system should be powered off before installation operation

1. Install the brackets to the base of the battery rack using 2 pcs M4\*10 socket head cap screws with locking torque of 2.5N · m.

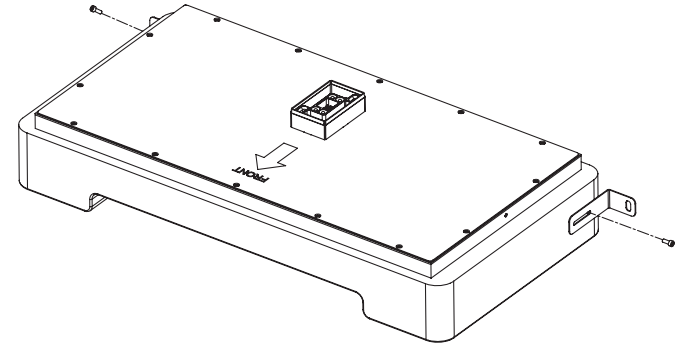

Figure 5-3

2. Install the brackets to the HV Box of the battery rack using 2 pcs M4\*10 socket head cap screws with locking torque of 2.5N · m.

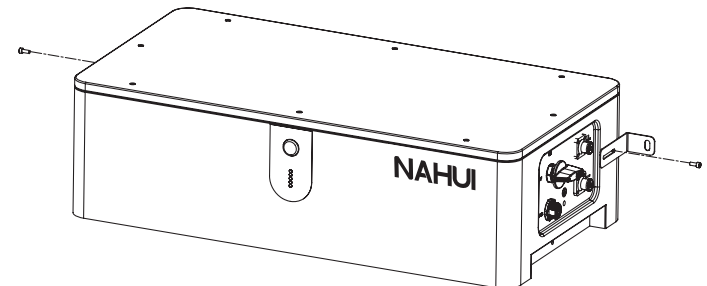

Figure 5-4

3. Place the base against the wall and mark the position of mounting holes on the wall. Remove the base and drill holes using an electric drill. The electric drill must with a dust cover to prevent dust from falling off.

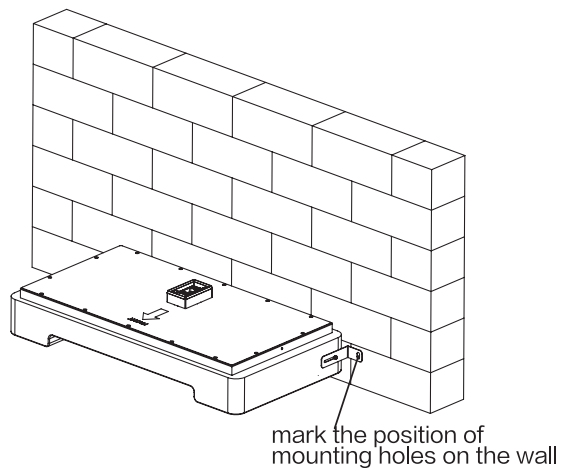

Figure 5-5



Figure 5-6

4. Place the base against the wall and fix the base to the wall with position of mounting holes on the wall with 2 pcs M6 expansion screws by  $8N \cdot m$ .

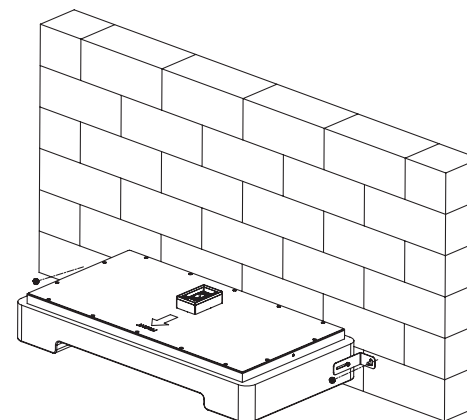

Figure 5-7

5. Then lay the battery module one by one on the base, and fix all the M4\*8 sunk screws on the left side and right side(each module have 4 fixed point)by  $2N \cdot m$ .

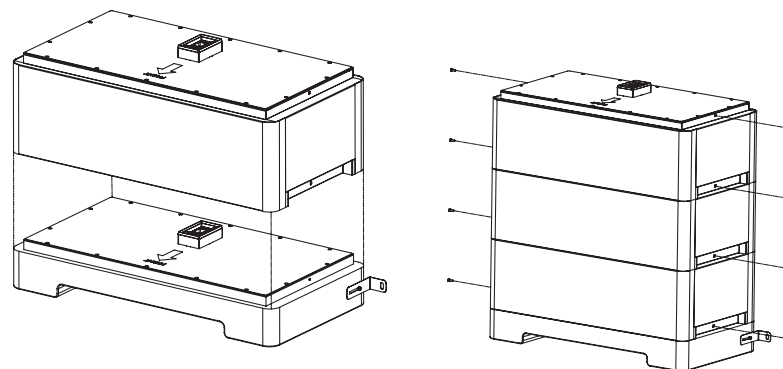

Figure 5-8

6. Place the HV box on the top of the module and mark the position of mounting holes on the wall. Remove the HV box and put a dust cover over the top of the module and then drill holes using an electric drill to prevent dust from falling off. Place the HV box back and fix the base to the wall with position of mounting holes on the wall with 2 pcs M6 expansion screws by 8N · m.

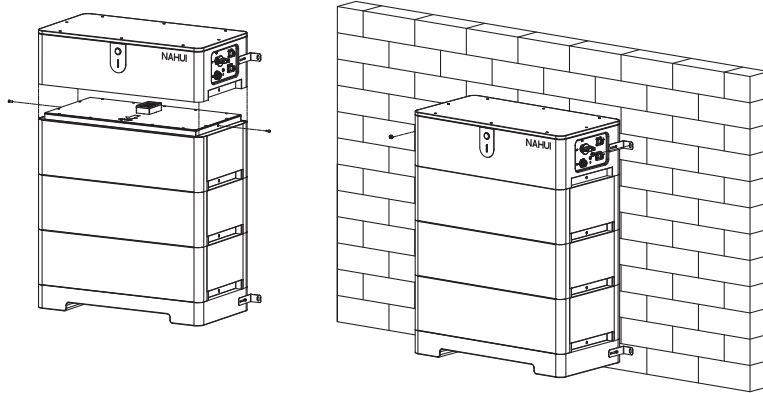

Figure 5-9

7. Connect the ground cable, power cable and communication cable between PCS and battery rack .

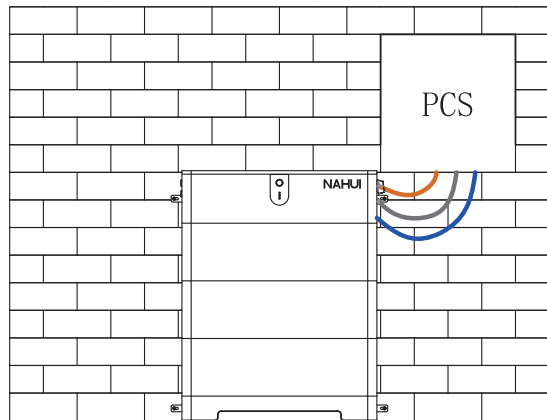

Figure 5-10

## 5.5 System turns on

Warning: Double check all the power cables and communication cables. Make sure the voltage of the inverter/PCS is same level with the battery system before connection. Check all the power switches are OFF.

System turns on step:

- (1) Check all cables are connected correctly. Check grounding is connected.
- (2) If necessary, turn on the switch at inverter's battery side or between inverter and battery. If possible, turn on AC or PV power source to wake up inverter.
- (3) Switch all the battery racks' Isolating Switch to on position.
- (4) Press the battery START button in turn, turn on the START metal button of the slave battery firstly, and finally turn on the START button of the master battery (1 master battery rack and 7 slave battery racks at most can be configured).
- (5) If no alarm, the battery system will be ready for charging and discharge with PCS.

## 5.6 System turns off

When failure or before service, must turn the battery storage system off:

- (1) Turn off the supply on the inverter side or turn off inverter.
- (2) Turn off the switch between PCS and battery system.
- (3) Switch Isolating Switch to off position. (Switch off the slave battery firstly, finally switch off the master battery)

## Note

- (1) One battery system shall just have one master, all the others are slaves. (The one on the extreme side connected to inverter is the master battery.)
- (2) It is forbidden to switch off the Isolating Switch during charging and discharging.

## 6 Emergency Situations

### 6.1 Battery Leakage

If the battery pack leaks electrolyte, avoid contact with the leaking liquid or gas. If one is exposed to the leaked substance, immediately perform the actions described below.

- (1) Inhalation: Evacuate contaminated area and seek medical aid.
  - (2) Contact with eyes: Rinse eyes with flowing water for 15 minutes and seek medical aid.
  - (3) Contact with skin: Wash affected area thoroughly with soap water and seek medical aid.
- Ingestion: Induce vomiting and seek medical aid.

### 6.2 On Fire

Only dry powder fire or carbon dioxide extinguisher can be used; if possible, move the battery module to a safe area before it catches fire.

### 6.3 Wet Batteries

If the module is wet or submerged in water, do not let people access it, then contact NAHUI or an authorized dealer for technical support. Cut off all power switch on inverter side.

### 6.4 Damaged Batteries

Damaged batteries are dangerous and must be handled with utmost care. They are not fit for use and may pose a danger to people or property. If the module seems to be damaged, pack it in its original container, then return it to authorized dealer.



Warning

Damaged batteries may leak electrolyte or produce flammable gas.

## 7 Remarks

### 7.1 Recycle and Disposal

In case a battery (normal condition or damaged) needs disposal or needs recycling, it shall follow the local recycling regulation (i.e. Regulation (EC) N° 1013/2006 among European Union) to process, and using the best available techniques to achieve a relevant recycling efficiency.

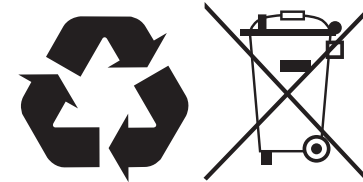

### 7.2 Maintenance

- (1) It is required to charge the battery at least once every 6 months, for this charge maintenance make sure the SOC is charged to higher than 85%.
- (2) Check installation environment such as dust, water, insect etc. Make sure it is suitable for IP65 battery system. Connection of power connector, grounding point, power cable and screw are suggested to be checked every year.

### 7.3 Declaration of conformity

The battery system described in this document complies with the applicable European directives.

## 8 Troubleshooting

Users can understand the fault status of the battery through indicator lights or monitoring software. Once the user knows the fault Phenomenon, refer to the following sections for solutions.

Fault Phenomenon	Cause	Solution
Button startup failed	The BMS is not activated by the button, and the battery cannot be turned on	1. Make sure the disconnecter is at ON position. 2. Check the status of buttons and cables. 3. Start up and check the BMS status through monitoring software. 4. If there is a hardware malfunction, please contact the local engineer.
No HV output	BMS and PCS communication fault	1. Make sure the communication cable connection is correct and contact. 2. Make sure the PCS protocol and other settings are correct. 3. If there is a hardware malfunction like the fuse and contactor, please contact the local engineer.
Charging/discharging Over Temperature Protection	The cell temperature is higher than the cell temperature protection value.	1. Install the battery in the allowed temperature environment. 2. Restart after 1 hour of system shutdown
Charging/discharging Under Temperature Protection	The ambient temperature is too low, causing the cell temperature to be lower than the minimum allowable temperature.	1. Install the battery in the allowed temperature environment. 2. When the temperature of the battery cell exceeds the threshold, turn on the system.
Ambient Over Temperature Protection	The ambient temperature of the battery is higher than the maximum allowable temperature of the system	1. Please shut down the system. 2. Restart after 1 hour. 3. If the malfunction occurs again, please contact the local engineer.
Ambient Under Temperature Protection	The ambient temperature of the battery is lower than the maximum allowable temperature of the system	1. Please install the battery in the allowed temperature environment according to the user manual
Charging/discharging Over Current Protection	Due to load or hardware reasons, the charging and discharging current is above the threshold.	1. Restart the inverter to see if the fault still exists. If it still exists, please contact the local engineer.
Charging Over Voltage Protection	Cell or battery voltage above threshold.	1. Shut down the system 2. Measure the battery port voltage and the BMS detection voltage to be the same. 3. If the fault cannot be eliminated after 1 hour, please contact the local engineer.
Discharging Under Voltage Protection	Cell or battery voltage below threshold	1. Please charge immediately until the fault disappears. 2. If the fault occurs frequently, please contact the local engineer.
Internal Fault	System production line hardware failure, unable to charge and discharge	1. Check if the internal communication cable. 2. Check BMS for any errors. 3. Check if the sampling line of the battery cell. 4. If the fault cannot be eliminated, please contact the local engineer.
Excessive voltage difference	The voltage difference between battery cells is greater than the threshold	1. Measure the actual voltage of the battery cell through an instrument. 2. Battery damage, please contact the local engineer.
Low Battery	Battery level below threshold due to prolonged standby or discharge	1. Please charge immediately until the fault disappears.

Qingdao Nahui Energy Technology Co., LTD.

**Address:** Room 303, Entrance 1, No. 4 Building,

Lan Gu Entrepreneurship Center Phase 1, No. 7, Keji Yilu Road,

Aoshanwei Sub district Office, Jimo District Office, Jimo District,

Qingdao, Shandong

**Web:** [www.nahui-newenergy.com](http://www.nahui-newenergy.com)

# NAHUI

# User manual

High Voltage Energy Storage System



NHS-1Y10K  
NHS-1Y15K  
NHS-1Y20K  
NHS-1Y25K  
NHS-1Y30K  
NHS-1Y35K  
NHS-1Y40K